

# Data Sheet

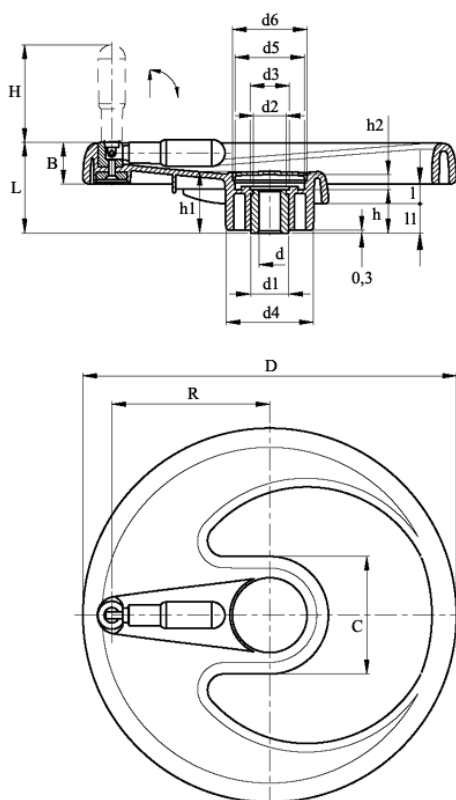

Article number: 23052047114  
Description: E+G Handwheel  
EMW.350+IR-A20-C4

## Measures



$B = 38$	$d_6 = 70$	$l_1 = 25$
$C = 108$	$d_3 = 35$	$R = 148$
$D = 350$	$H = 90$	
$d_1 = 35$	$h = 38$	
$d_2 = 33$	$h_1 = 55$	
$d_3 = 35$	$h_2 = 14$	
$d_4 = 82$	$l = 19$	
$d_5 = 69$	$L = 82$	